



## Elektrikli Bisiklet Konnektörleri & Kablo Çözümleri

Elektrikli bisikletler sürücülerin doğadan keyif alarak ve zorlu koşullarda yol almasını sağlayan akıllı ve kompakt araçlardır.

TTAF, keyifli bir sürüş için tüm bağlantı ihtiyaçlarını karşılayan e-bisiklet konnektörleri tasarlar ve üretir.

Today, Tomorrow And Forever...

# E-Bisiklet

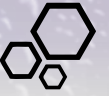

M6

M8,M9,M10



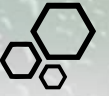

# E-Motosiklet

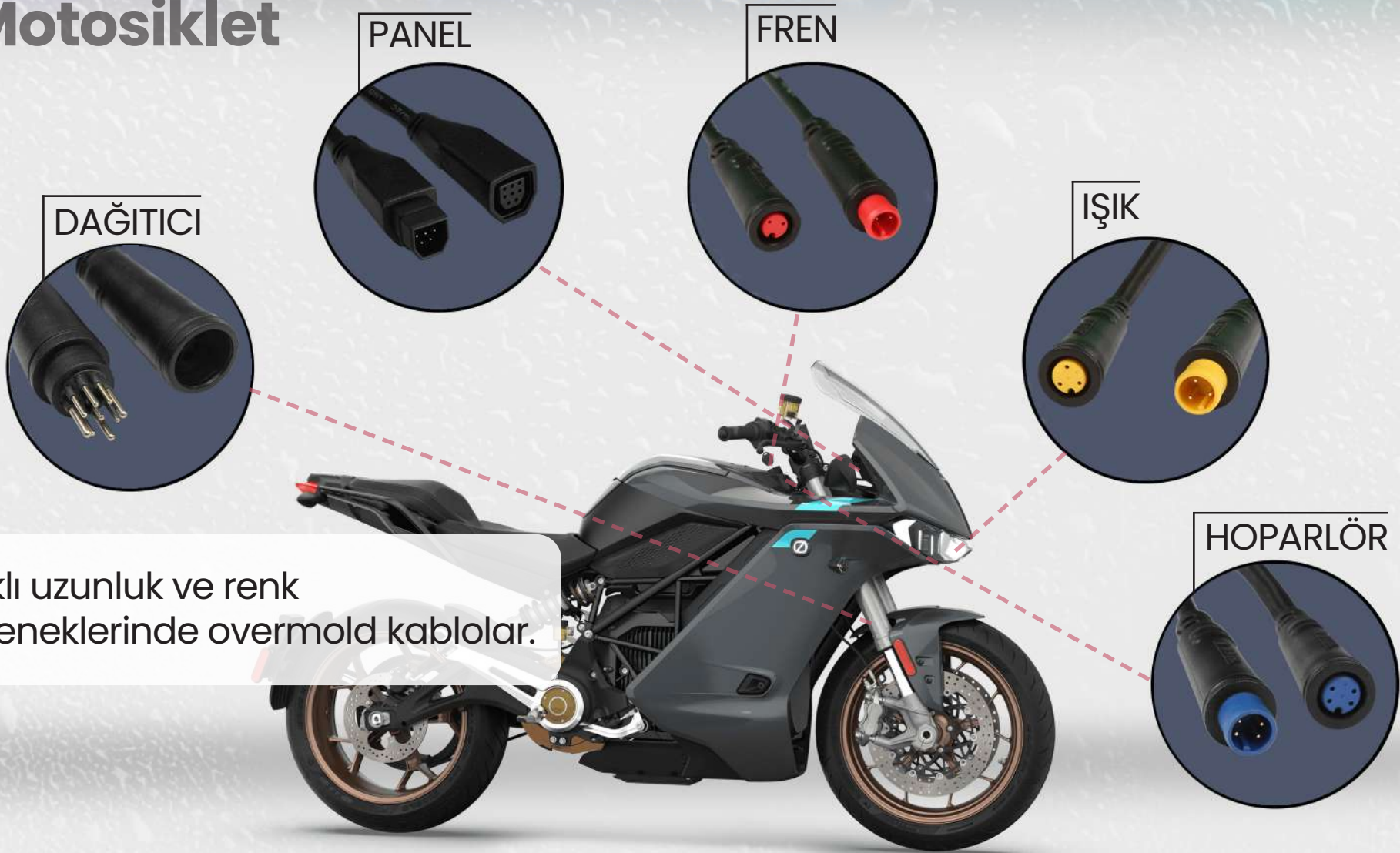

Farklı uzunluk ve renk seçeneklerinde overmold kablolar.

M6

M8,M9,M10



# Elektrikli Kaykay

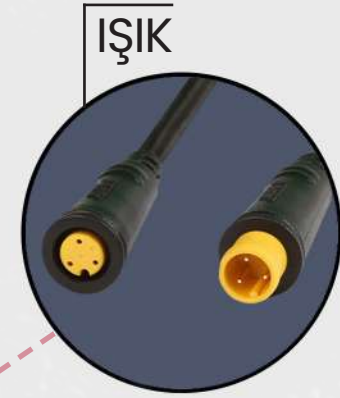
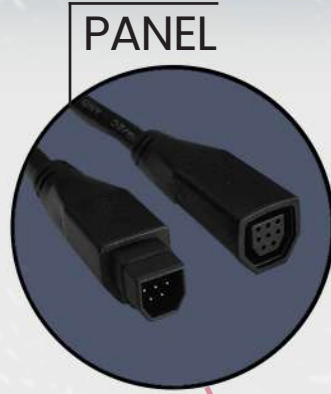
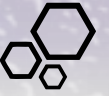

Kolay kurulum.



M6

M8,M9,M10



# Elektrikli Scooter

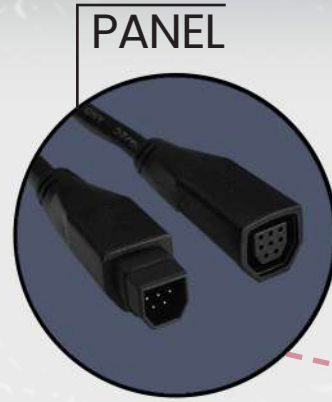
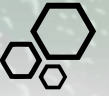

Özel tasarımlar ve özel konnektör kombinasyonları.



M6

M8,M9,M10





# M Serisi Su Geçirmez Konnektörler & Kablolar

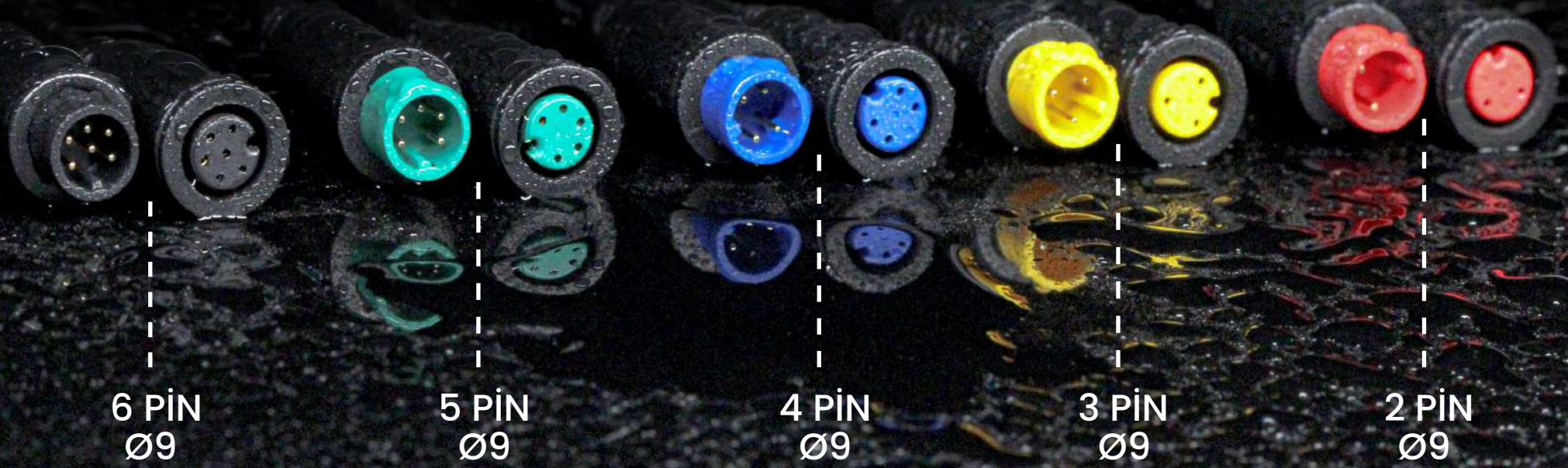

6 PİN  
Ø9

5 PİN  
Ø9

4 PİN  
Ø9

3 PİN  
Ø9

2 PİN  
Ø9

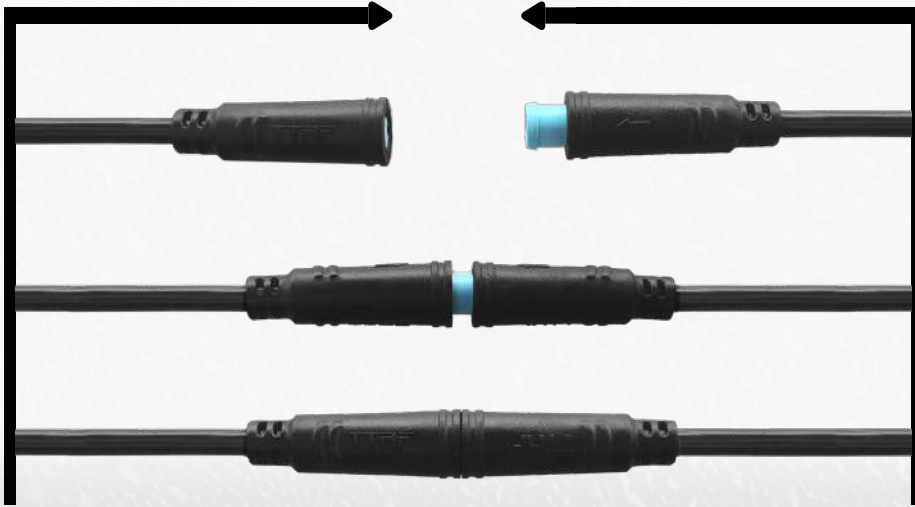
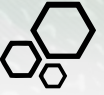

## Akıllı ve Kompakt

M serisi konnektörler çeşitli uygulamalarda kullanılabilen güvenli ve sağlam bir seçenektir. Kompakt dizaynları ve kablodan kabloya bağlantı özelliği sayesinde kolayca montaj ve bakımı yapılabilir.

Sensörleri, aktüatörleri veya diğer cihazları bağlamanız gerektiğinde, M serisi konnektörler dış ortamda ve ağır şartlarda kullanıldığından dolayı sağlam ve dayanıklı yapıdadır..

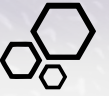

**M6-2 PİN**  
Erkek/Dişi

Ürün Yapısı:	2 PİN
IP Sınıfı:	IP65
Ortam Sıcaklığı:	-20°C~+80°C
Anma Gerilimi:	60V
Dayanma Gerilimi:	500V
Kontakt Direnci:	≤10mΩ
Yalıtım Direnci:	≥20MΩ



**M6-3 PİN**  
Erkek/Dişi

Ürün Yapısı:	3 PİN
IP Sınıfı:	IP65
Ortam Sıcaklığı:	-20°C~+80°C
Anma Gerilimi:	60V
Dayanma Gerilimi:	500V
Kontakt Direnci:	≤10mΩ
Yalıtım Direnci:	≥20MΩ



**M6-4 PİN**  
Erkek/Dişi

Ürün Yapısı:	4 PİN
IP Sınıfı:	IP65
Ortam Sıcaklığı:	-20°C~+80°C
Anma Gerilimi:	60V
Dayanma Gerilimi:	500V
Kontakt Direnci:	≤10mΩ
Yalıtım Direnci:	≥20MΩ



**M6-5 PİN**  
Erkek/Dişi

Ürün Yapısı:	5 PİN
IP Sınıfı:	IP65
Ortam Sıcaklığı:	-20°C~+80°C
Anma Gerilimi:	60V
Dayanma Gerilimi:	500V
Kontakt Direnci:	≤10mΩ
Yalıtım Direnci:	≥20MΩ



**M6-6 PİN**  
Erkek/Dişi

Ürün Yapısı:	6 PİN
IP Sınıfı:	IP65
Ortam Sıcaklığı:	-20°C~+80°C
Anma Gerilimi:	60V
Dayanma Gerilimi:	500V
Kontakt Direnci:	≤10mΩ
Yalıtım Direnci:	≥20MΩ

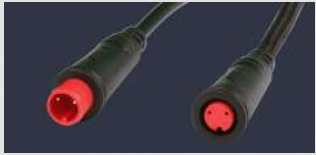

**M8-2 PİN**  
Erkek/Dişi

IP Sınıfı:	IP67
Ortam Sıcaklığı:	-25°C~+85°C
Anma Gerilimi:	48V
Dayanma Gerilimi:	500V
Kontakt Direnci:	≤10mΩ
Yalıtım Direnci:	≥20MΩ
Mekanik Operasyon:	≤200 Eşleştirme Döngüsü
Kablo kesit Alanı:	0.14m2~0.2m2



**M8-3 PİN**  
Erkek/Dişi

IP Sınıfı:	IP67
Ortam Sıcaklığı:	-25°C~+85°C
Anma Gerilimi:	48V
Dayanma Gerilimi:	500V
Kontakt Direnci:	≤10mΩ
Yalıtım Direnci:	≥20MΩ
Mekanik Operasyon:	≤200 Eşleştirme Döngüsü
Kablo kesit Alanı:	0.14m2~0.2m2



**M8-4 PİN**  
Erkek/Dişi

IP Sınıfı:	IP67
Ortam Sıcaklığı:	-25°C~+85°C
Anma Gerilimi:	48V
Dayanma Gerilimi:	500V
Kontakt Direnci:	≤10mΩ
Yalıtım Direnci:	≥20MΩ
Mekanik Operasyon:	≤200 Eşleştirme Döngüsü
Kablo kesit Alanı:	0.14m2~0.2m2



**M8-5 PİN**  
Erkek/Dişi

IP Sınıfı:	IP67
Ortam Sıcaklığı:	-25°C~+85°C
Anma Gerilimi:	48V
Dayanma Gerilimi:	500V
Kontakt Direnci:	≤10mΩ
Yalıtım Direnci:	≥20MΩ
Mekanik Operasyon:	≤200 Eşleştirme Döngüsü
Kablo kesit Alanı:	0.14m2~0.2m2



**M8-6 PİN**  
Erkek/Dişi

IP Sınıfı:	IP67
Ortam Sıcaklığı:	-25°C~+85°C
Anma Gerilimi:	48V
Dayanma Gerilimi:	500V
Kontakt Direnci:	≤10mΩ
Yalıtım Direnci:	≥20MΩ
Mekanik Operasyon:	Eşleştirme Döngüsü
Kablo kesit Alanı:	0.14m2~0.2m2



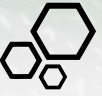

### M10 - 8 PİN Erkek/Dişi

Ürün Yapısı:	8 PİN
IP Sınıfı:	IP67
Ortam Sıcaklığı:	-25°C~+85°C
Anma Gerilimi	60V
Dayanma Gerilimi	700V
Kontakt Direnci:	≤10mΩ
Yalıtım Direnci:	≥20MΩ
Kablo Kesit Alanı:	0.2m2~2.0m2



### M10 - 9 PİN Erkek/Dişi 3 Güç + 6 Sinyal

Ürün Yapısı:	9 PİN
IP Sınıfı:	IP67
Ortam Sıcaklığı:	-25°C~+85°C
Anma Gerilimi	60V
Dayanma Gerilimi	700V
Kontakt Direnci:	≤10mΩ
Yalıtım Direnci:	≥20MΩ
Kablo Kesit Alanı:	0.2m2~2.0m2



### M9 - 6 PİN Erkek/Dişi 2 Güç + 4 Sinyal

Ürün Yapısı:	6 PİN
IP Sınıfı:	IP67
Ortam Sıcaklığı:	-25°C~+85°C
Anma Gerilimi	60V
Dayanma Gerilimi	700V
Kontakt Direnci:	≤10mΩ
Yalıtım Direnci:	≥20MΩ
Kablo Kesit Alanı:	0.2m2~2.0m2



# M Serisi Su Geçirmez Konnektörler & Kablolar



9 PIN  
Ø14.5

6 PIN  
Ø12.5

## PARÇA NUMARASI OLUŞTURMA:

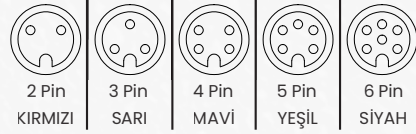
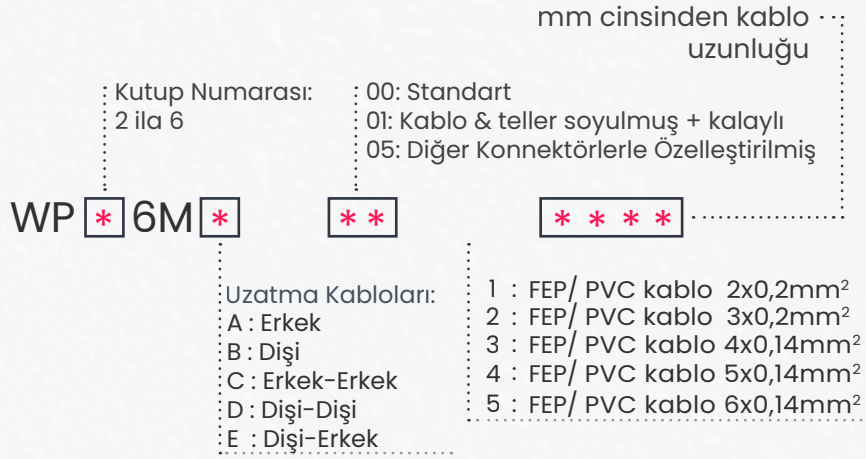

## M6 Erkek

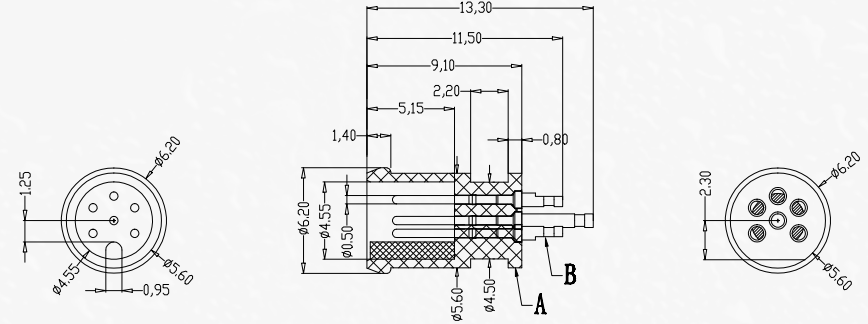

## M6 Dişi

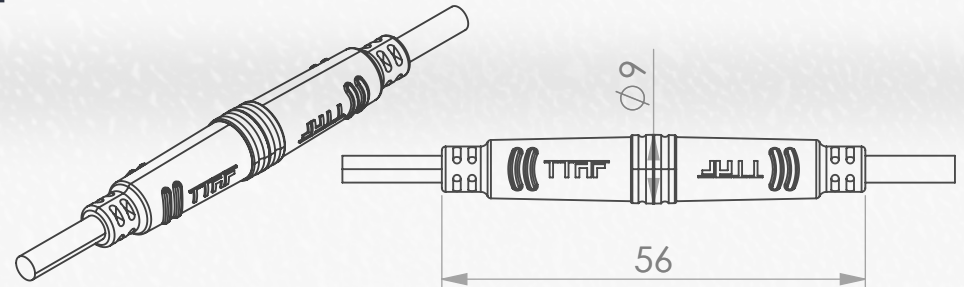
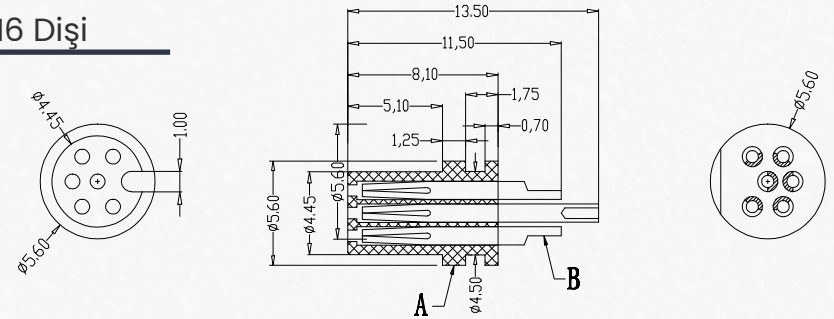

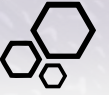

## PARÇA NUMARASI OLUŞTURMA:

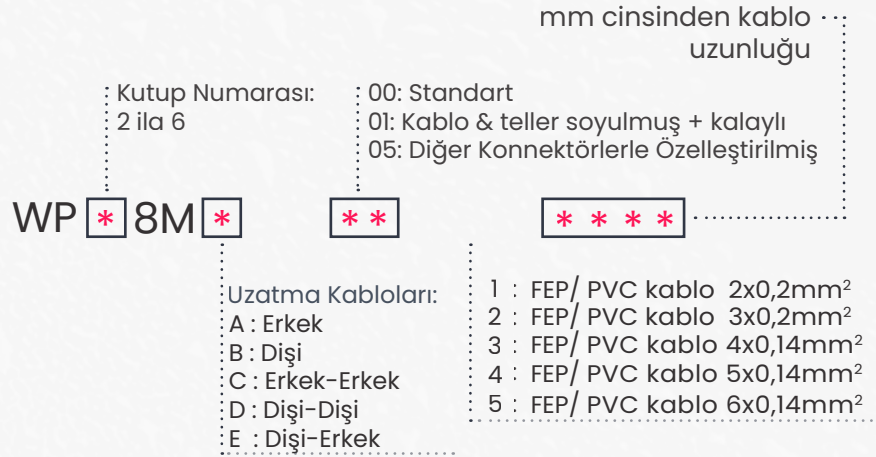

## M8 Erkek

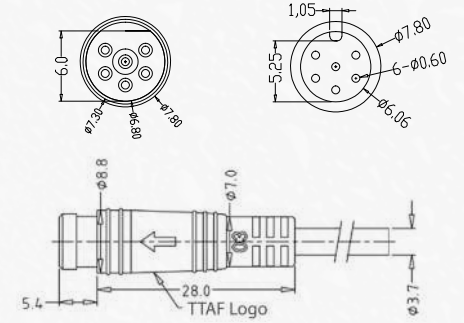
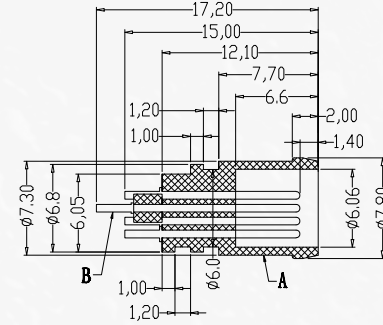

## M8 Dişi

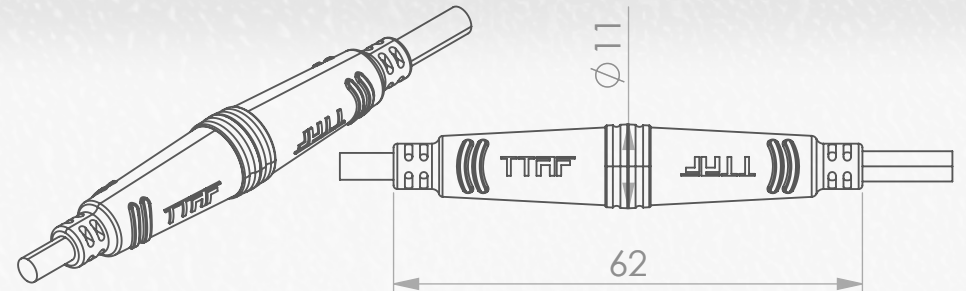
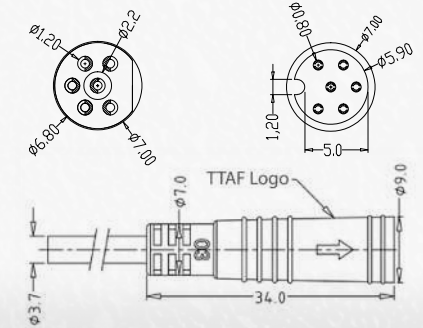
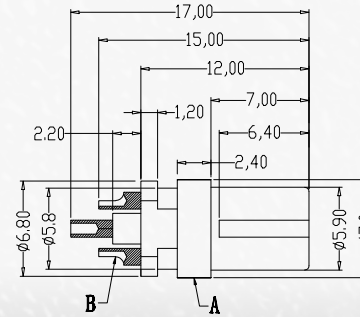

## PARÇA NUMARASI OLUŞTURMA:

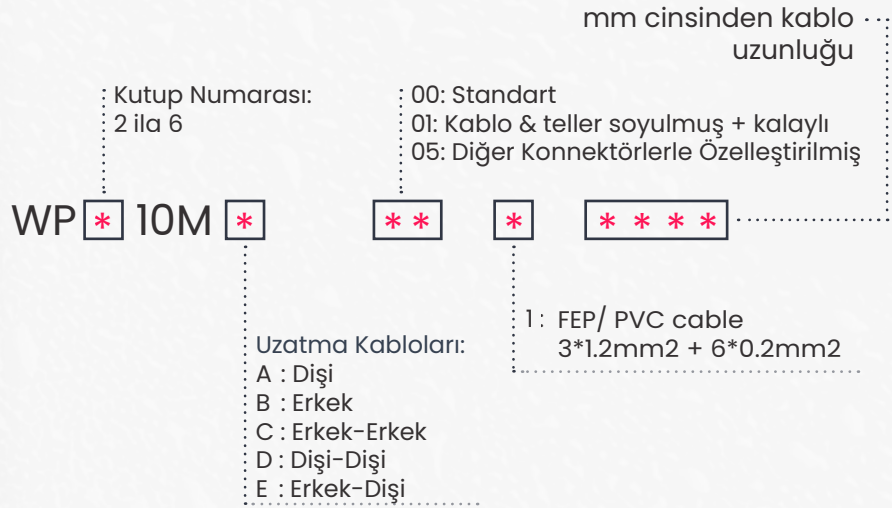

## M10 - 9 PİN Erkek

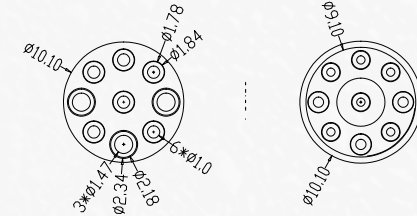
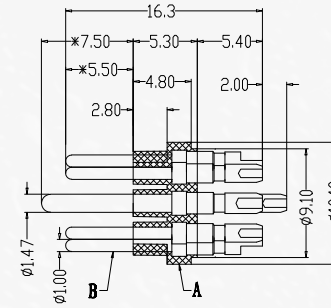

## M10 - 9 PİN Dişi

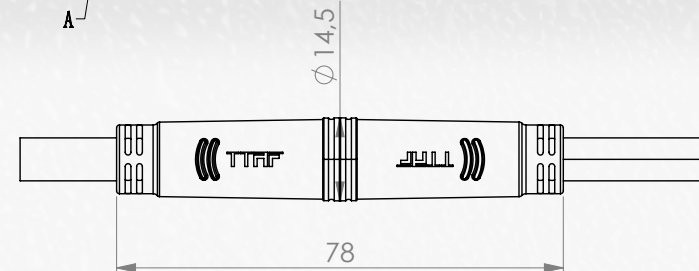
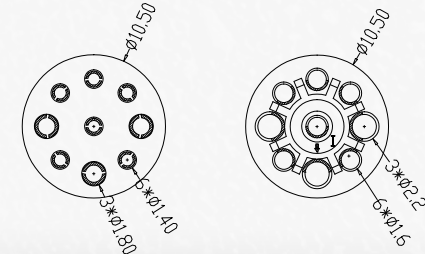
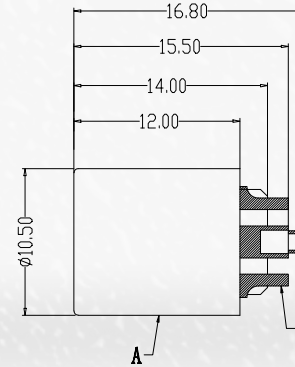

## PARÇA NUMARASI OLUŞTURMA:

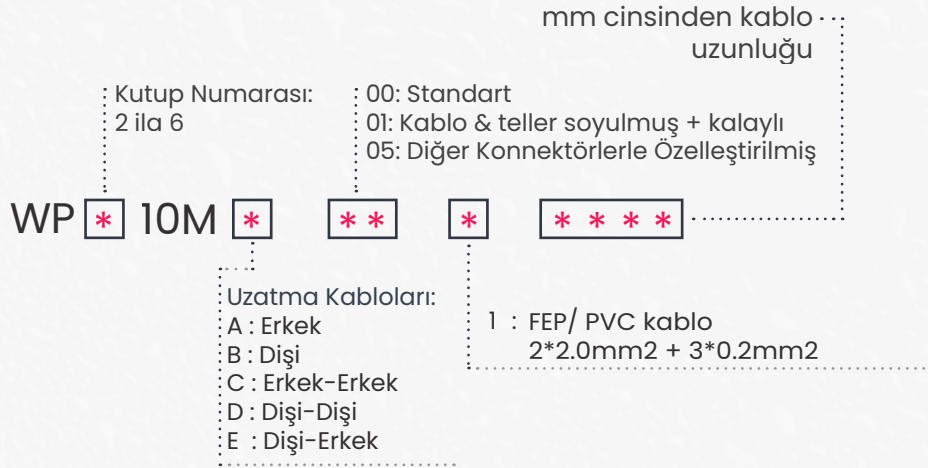

## M10 - 8 PİN Erkek

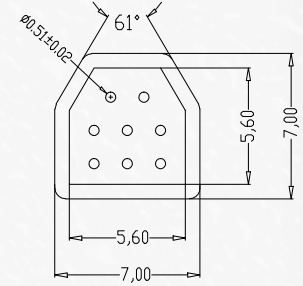
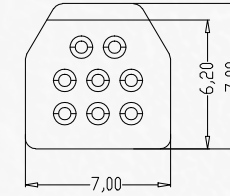
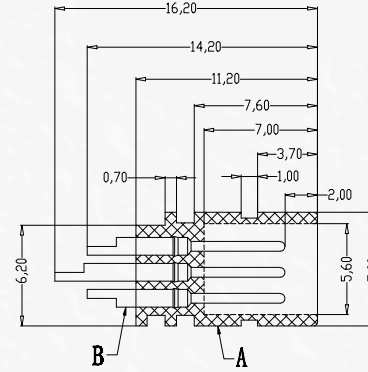

## M10 - 8 PİN Dişi

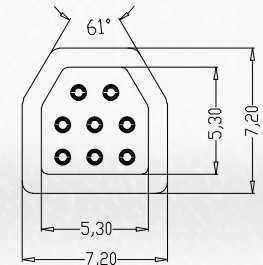
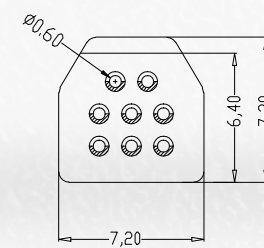
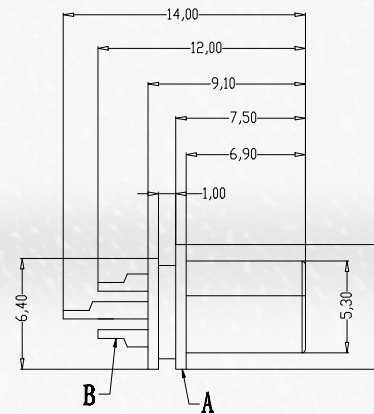

## PARÇA NUMARASI OLUŞTURMA:

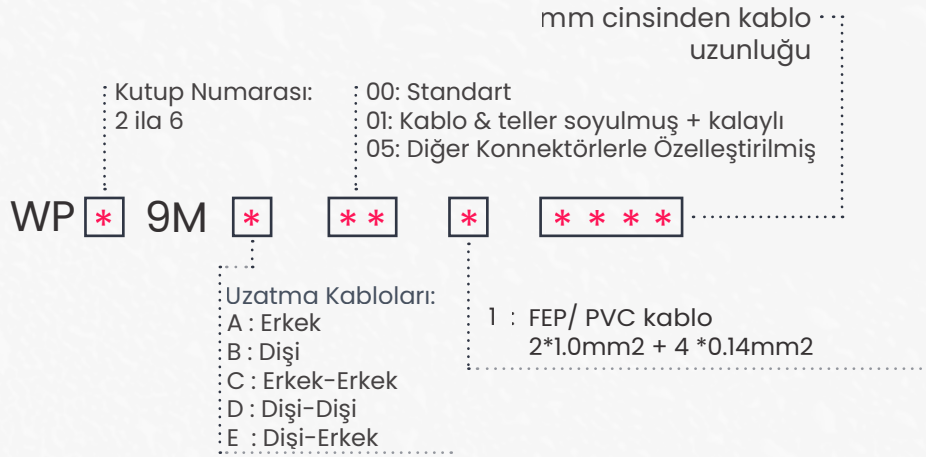

## M9 - 6 PİN Erkek

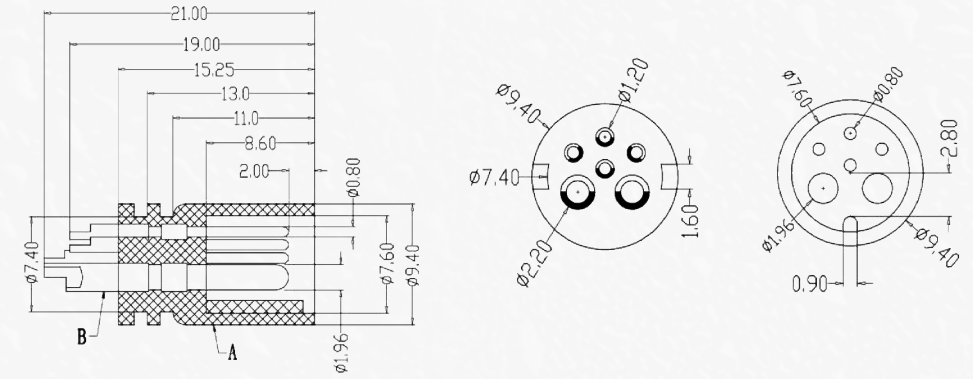

## M9 - 6 PİN Dişi

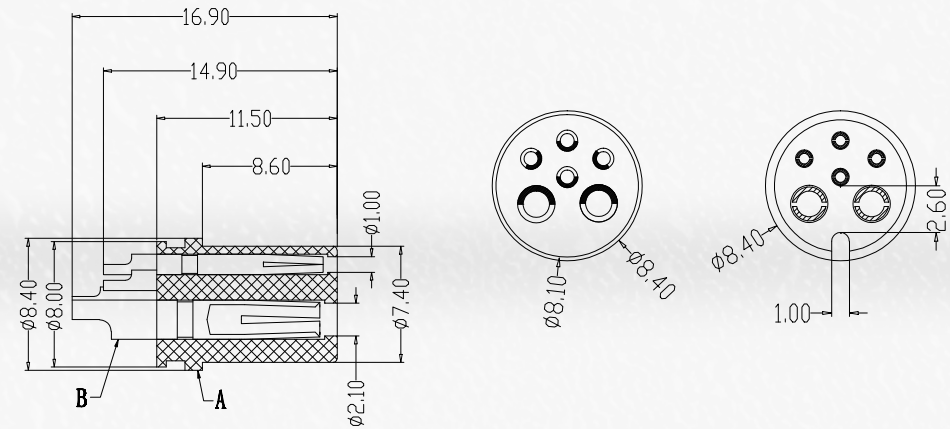

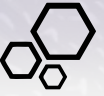

## E-Bike Aksesuarları

M6 ve M8 Signal konektörleri Güç'ten Type-C'ye veya Güç'ten Lightning'e birleştirilebilir. Bu sayede e-bisikletiniz ile telefonunuzu veya elektronik cihazınızı şarj edebilirsiniz.

Güç'ten Type-C'ye



Güç'ten Lightning'e





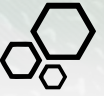

## BATARYA KABLOSU

Konnektörlere ve overmolding kablolara ek olarak; TTAF, müşteri spesifikasyonlarına göre her türlü kablo grubu üretme yeteneğine sahiptir.





Keyifli Sürüşler!

[www.ttafconsumer.com](http://www.ttafconsumer.com)

